

MS01-MW-HW-DC Motion Sensor

Suitable for select VT4 fixtures

- On/Off Control
- Motion Detection
- Hold Time
- Daylight Sensor
- Stand-by Period
- Stand-by Dimming Level

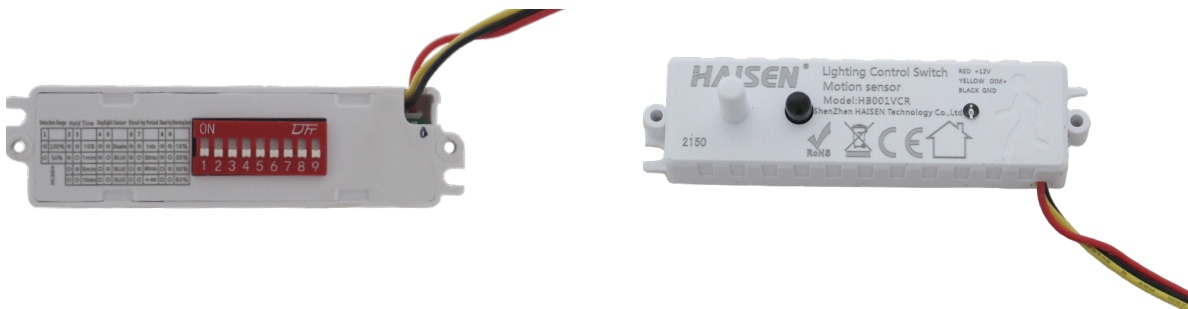

WIRING DIAGRAM

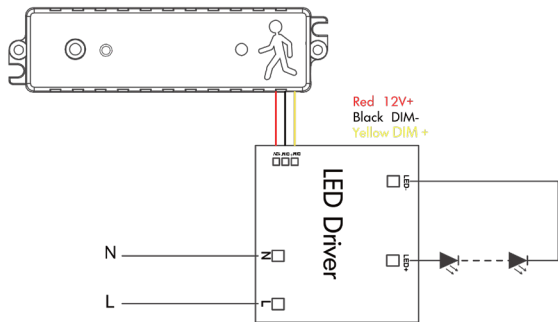

DIMENSIONS (MM)

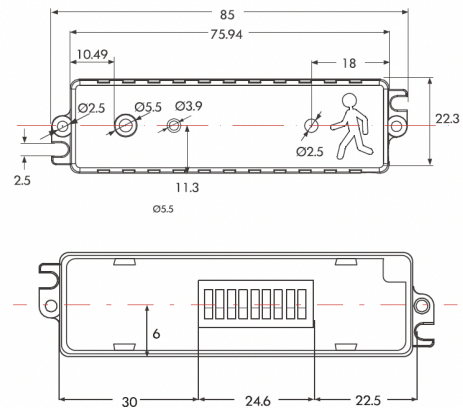

MECHANICAL UNIT

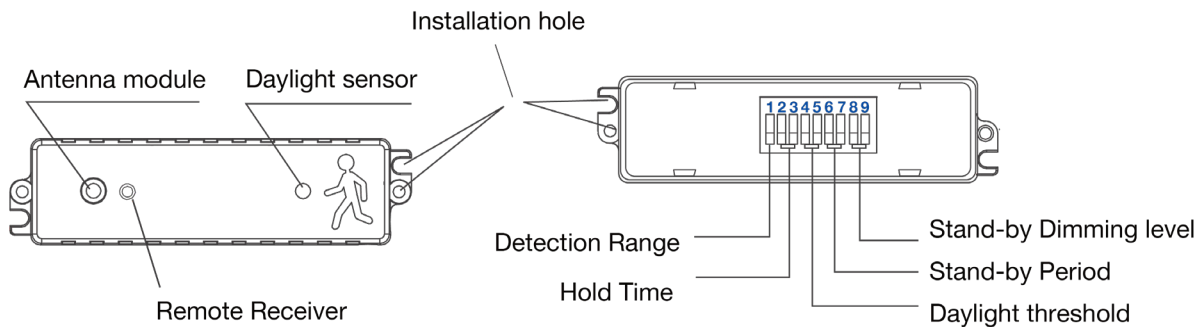

TECHNICAL DATA

TECHNICAL DATA

Operating Voltage	10.5-15V
Output	0-10V
Stand-by Power	≤ 0.5W
Detection Area	DIP Switch: 50% 100% Remote: 25% 50% 75% 100%
Stand-by Dimming	DIP Switch: 10% 20% 30% 50% 100% Remote: 10% 20% 30% 50% 100%
Microwave Frequency	5.8GHz ± 75MHz
Microwave Power	<0.3mW
Mounting Height	4 metres max (Ceiling Mounted)
Detection Range	10m x 4m diameter
Operating Temp	-20°C to 60°C
IP Rating	IP20

DETECTION COVERAGE

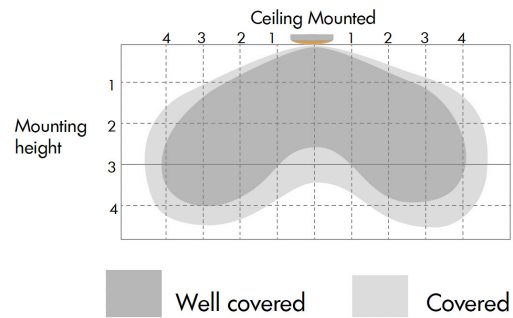

NOTE: Optional Remote Control (HB7B-REMOTE) sold separately

APPLICATION - DIMMABLE CONTROL

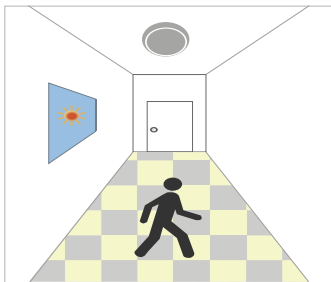

With sufficient ambient brightness, the light remains OFF when motion is detected.



With insufficient ambient brightness, the light turns ON when motion is detected.

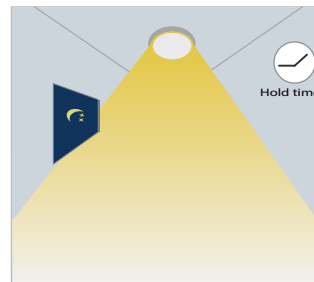

Light dims to stand-by level (10%, 20%, 30% or 50%) if no motion is detected after holdtime.

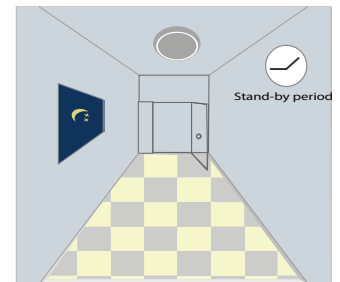

After the stand-by period, light turns OFF.

SENSOR SETTINGS

DETECTION AREA	HOLD TIME	DAYLIGHT THRESHOLD	STAND-BY PERIOD	STAND-BY DIMMING LEVEL
<input checked="" type="radio"/> 100%	<input checked="" type="radio"/> 10s	<input checked="" type="radio"/> Disable	<input checked="" type="radio"/> 1min	<input checked="" type="radio"/> 10%
<input type="radio"/> 50%	<input type="radio"/> 1min	<input type="radio"/> 50lux	<input type="radio"/> 30min	<input type="radio"/> 20%
	<input type="radio"/> 5min	<input type="radio"/> 30lux	<input type="radio"/> 60min	<input type="radio"/> 30%
	<input type="radio"/> 10min	<input type="radio"/> 10lux	<input type="radio"/> +∞	<input type="radio"/> 50%

Detection Area

Movement will be detected and trigger the sensor depending on the set sensitivity.

Hold Time

The period of time the fixture stays on after motion is no longer detected.

Daylight Threshold

When the ambient brightness is lower than the set lux, the fixture will turn on. When set to DISABLE, the fixture will always work, regardless of ambient light.

Stand-by Period

The length of time before the fixtures turn off completely. When it's set to "∞", the light will always stay dimmed.

Stand-by Dimming

Set the level of light output in the stand-by period.

HEAD OFFICE: 8 - 540 Jamieson Pkwy, Cambridge, ON, N3C 0G5 | orders@csc-led.com | (519) 880 - 9833